

BARRY

by Alain Gilles

 design Nation



Barry è un tavolo dall'impronta grafica, che indaga sulle percezioni dei propri volumi, tra solidità e leggerezza. Le gambe, protagoniste, si arricciano su se stesse con decisione, mostrando la personalità dinamica del tavolo.

Barry promette sicurezza, in casa oppure in ufficio.

Barry is a distinctly graphic table sporting intriguing volumes, a mixture of solidity and lightness. The legs form a prominent feature and curl distinctly around themselves, revealing the table's dynamic personality. Barry provides reassurance in the home or office.

DIMENSIONI | DIMENSIONS



*lunghezza | width: 155 cm
larghezza | depth: 155 cm
altezza | height: 75,8/76,4/76 cm

**lunghezza | width: 165 cm
larghezza | depth: 165 cm
altezza | height: 75,8/76,4/76 cm

***lunghezza | width: 180 cm
larghezza | depth: 180 cm
altezza | height: 75,8/76,4/76 cm

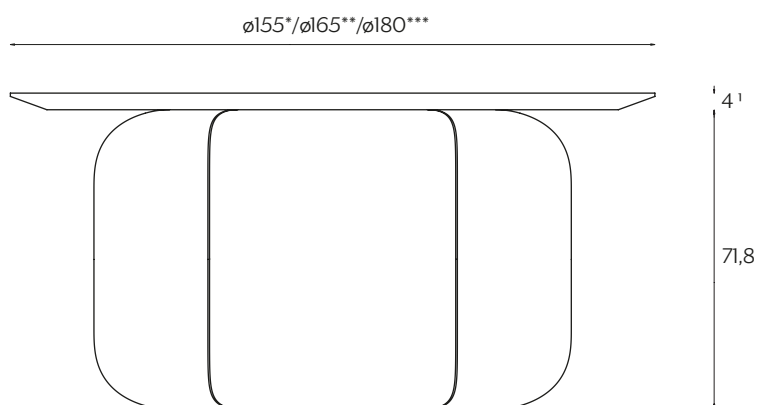

AMBIENTE | ENVIRONMENT

interno | indoor

DOWNLOAD | DOWNLOADS

la guida Cura e Manutenzione è disponibile su miniforms.com
Care and Maintenance guide is available at miniforms.com

file 2D, 3D e fotografie sono disponibili su miniforms.com
2D, 3D files and hi-res images are available at miniforms.com

¹ spessore per piani in legno; piano in ceramica 4,6 cm, piano in marmo Palladio Moro 4,2 cm
thickness for wooden tops; ceramic tops 4,6 cm, Palladio Moro marble top 4,2 cm

FINITURE | FINISHES

PIANO | TOP

Legno | Wood



Rovere
Fiammato
Flamed Oak



Rovere Vintage
Vintage Oak

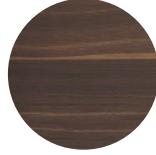

Rovere
Termotrattato
Heat-Treated Oak



Frassino Nero
Black Ash



Noce Canaletto
Canaletto
Walnut

Gres Porcellanato | Porcelain Stoneware (Ceramic)



Statuario Bianco
Statuario White



Thundernight
Thundernight

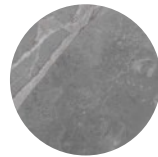

Étoile Gris
Étoile Gris

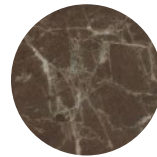

Emperador
Emperador

Laccati | Lacquer

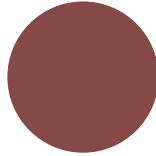

Rosso Marsala
Marsala Red
NCS S4040R

BASE | BASE

Laccati | Lacquer

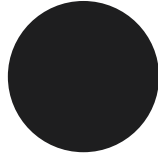

Nero
Black
RAL: 9005

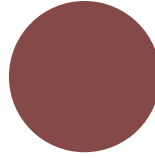

Rosso Marsala
Marsala Red
NCS S4040R

Metallo | Metal



Oro Rosa Opaco
Rose Gold Matt



Bronzè
Bronze

BARRY

by Alain Gilles

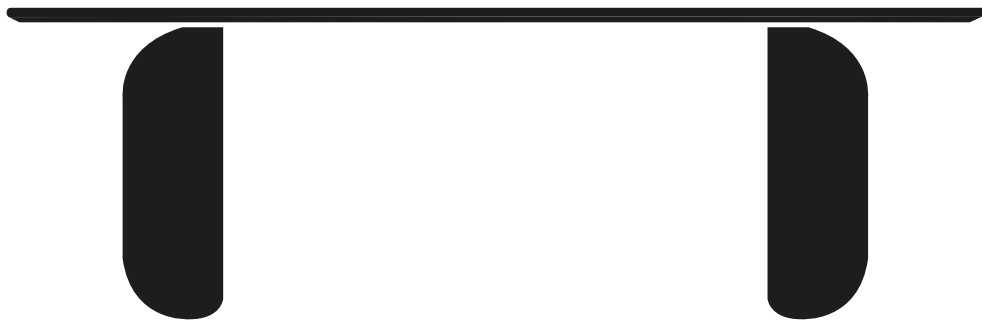

Barry è un tavolo dall'impronta grafica, che indaga sulle percezioni dei propri volumi, tra solidità e leggerezza. Le gambe, protagoniste, si arricciano su se stesse con decisione, mostrando la personalità dinamica del tavolo.

Barry promette sicurezza, in casa oppure in ufficio.

Barry is a distinctly graphic table sporting intriguing volumes, a mixture of solidity and lightness. The legs form a prominent feature and curl distinctly around themselves, revealing the table's dynamic personality. Barry provides reassurance in the home or office.

DIMENSIONI | DIMENSIONS



*lunghezza | width: 200 cm
larghezza | depth: 100 cm
altezza | height: 75,8/76,4/76 cm

**lunghezza | width: 240 cm
larghezza | depth: 100 cm
altezza | height: 75,8/76,4/76 cm

***lunghezza | width: 300 cm
larghezza | depth: 100 cm
altezza | height: 75,8/76,4/76 cm

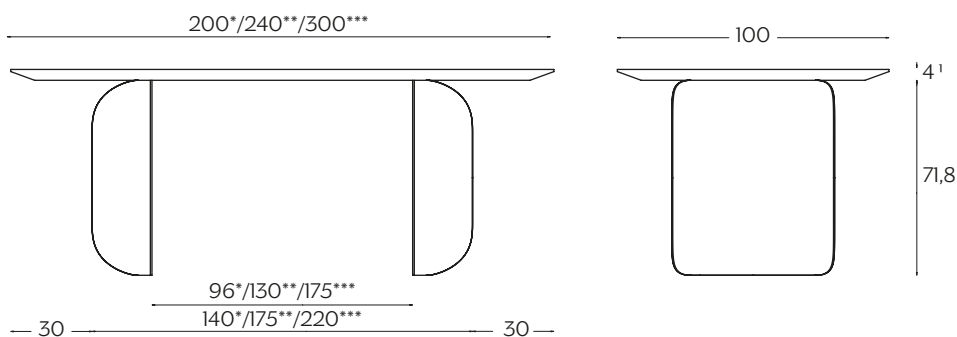

AMBIENTE | ENVIRONMENT

interno | indoor

DOWNLOAD | DOWNLOADS

la guida Cura e Manutenzione è disponibile su miniforms.com
Care and Maintenance guide is available at miniforms.com

file 2D, 3D e fotografie sono disponibili su miniforms.com
2D, 3D files and hi-res images are available at miniforms.com

FINITURE | FINISHES

PIANO | TOP

Legno | Wood



Rovere
Fiammato
Flamed Oak



Rovere Vintage
Vintage Oak



Rovere
Termotrattato
Heat-Treated Oak



Frassino Nero
Black Ash



Noce Canaletto
Canaletto
Walnut

Gres Porcellanato | Porcelain Stoneware (Ceramic)

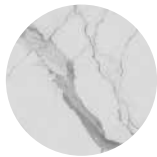

Statuario Bianco
Statuario White

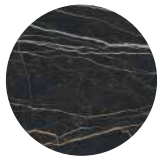

Thundernight
Thundernight

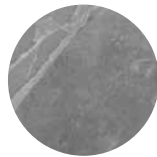

Étoile Cris
Étoile Cris

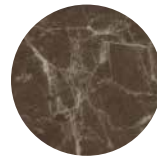

Emperador
Emperador

Marmo | Marble

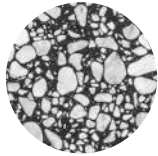

Palladio Moro



Palladio Doge

Laccati | Lacquer

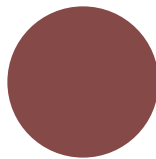

Rosso Marsala
Marsala Red
NCS S4040R

BASE | BASE

Laccati | Lacquer

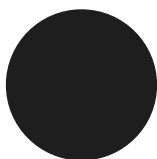

Nero
Black
RAL: 9005

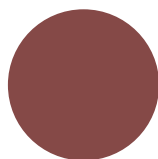

Rosso Marsala
Marsala Red
NCS S4040R

Metallo | Metal



Oro Rosa Opaco
Rose Gold Matt



Bronzè
Bronze