

CUP lounge chair design Konstantin Grcic

Mod. 1960-12

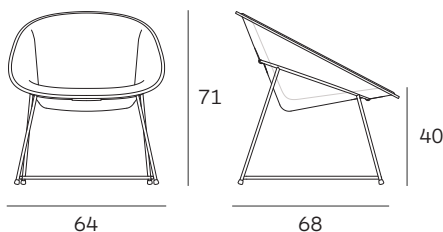

Poltroncina Lounge. Scocca in plastica nei colori nero e bianco. Imbottitura in schiumato poliuretano, rivestimenti in vari tipi di tessuti e colori abbinati alla scocca. Struttura in metallo cromato o verniciato a polvere nera.

Lounge chair. Seat shell in plastic in the colours black and white. Upholstery in various textiles and colours combined with the seat shell. Metal structure in chrome or black powder coated.

Lounge Sessel. Sitzschale aus Kunststoff in den Farben Schwarz und Weiß. Polsterung in verschiedenen Stoffen und Farben in Kombination zur Sitzschale. Metallgestell verchromt oder schwarz pulverbeschichtet.

Colori scocca / Seat shell colours / Farben Sitzschale

Finiture plastica / Plastic finishings / Kunststoffausführungen
ABS



Telaio / Frame / Gestell

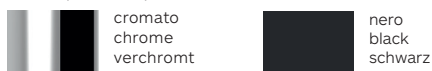

Finiture imbottitura / Finishings upholstery / Polsterausführungen
Tessuto / Fabric / Stoff

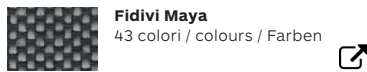
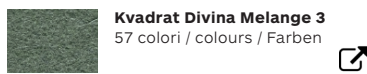
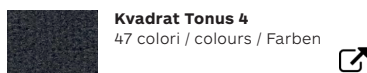
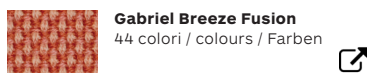
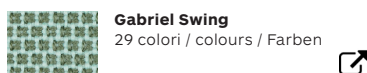
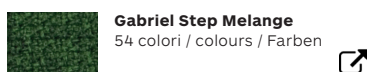

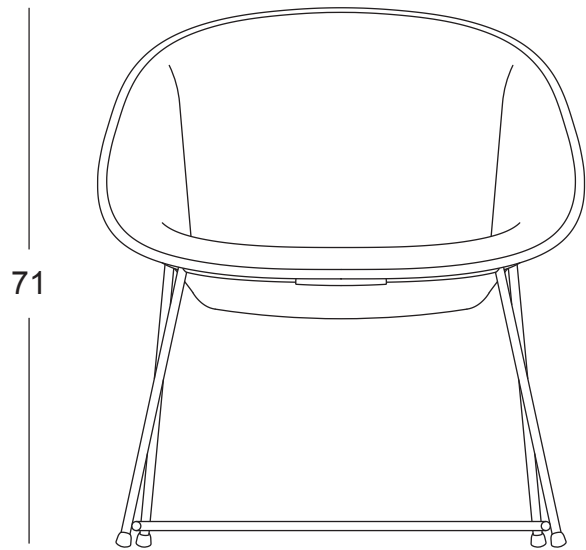

FRONT VIEW

64

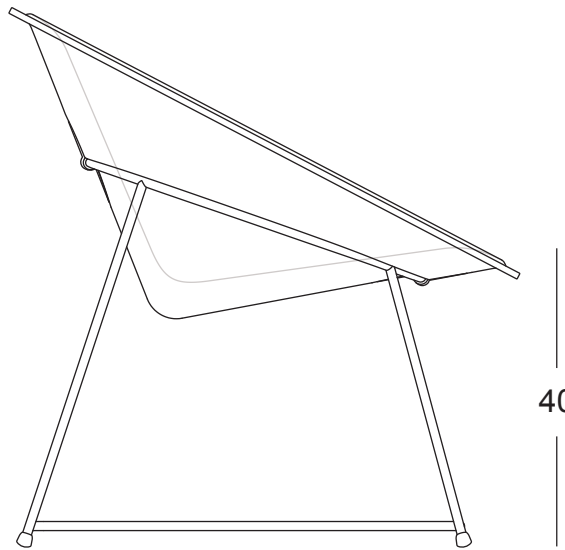

SIDE VIEW

68

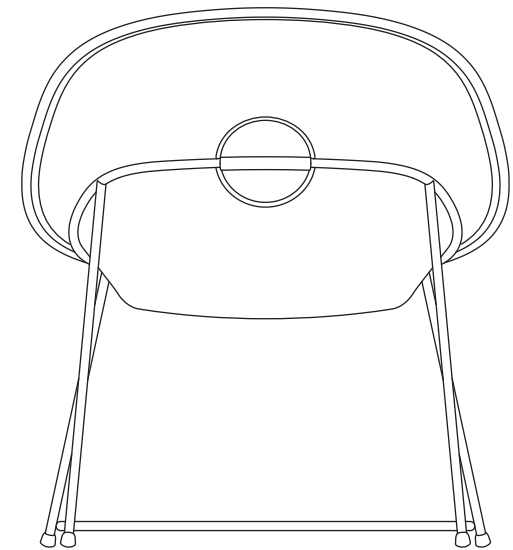

BACK VIEW

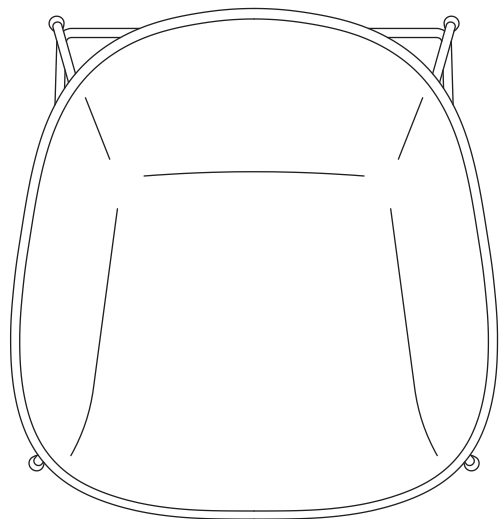

TOP VIEW